

# Specifications



1800374343

## ADGBA-1975

Deli Display

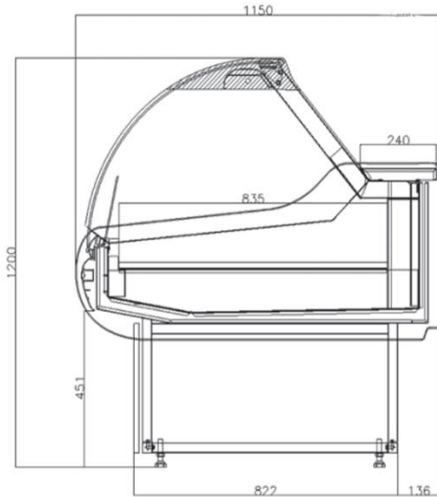

### CABINET DIMENSIONS

	External
<b>Height:</b>	1200mm
<b>Width:</b>	1975mm
<b>Depth:</b>	1150mm
<b>Floor area:</b>	2.27m <sup>2</sup>



### CABINET SPECIFICATIONS

<b>Refrigeration system:</b>	Electronic controlled, Ventilate Cooling
<b>Refrigerant / Charge:</b>	R404A
<b>Lid type :</b>	Open doors
<b>Cabinet temperature range:</b>	0°C to +5°C
<b>Condensate Water:</b>	Stainless steel automatic evaporation
<b>Electrical:</b>	220-240 Volts a.c. 50 Hz
<b>Power cord length:</b>	2.5m
<b>Internal lighting:</b>	1LED
<b>Bottom:</b>	Stainless steel
<b>Feet:</b>	Wheel or feet
<b>Insulation:</b>	50mm polyurethane foam
<b>Total weight:</b>	140 kg

Austune Australia Pty Ltd reserve the right to alter specifications without notice.

Austune Australia Pty Ltd

Unit 3, 35 Davis Road Wetherill Park NSW 2164

Tel: 02 9725 1578